

INSTRUCTIONS Please read carefully before assembly!

nolastar® by **Royal Family** designlabor

25 plates (19.3 x 19.3 cm)
60 connecting rings
5 rotating swivel eyes
1 pair of cotton gloves

- per square meter
- for connecting the individual plates
- are mounted on the upper end of the curtain in order to push these together
- to avoid unnecessary fingerprints during installation

① superpose matt surfaces

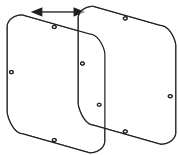

② lead 1 connecting ring by the holes of both plates

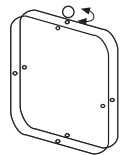

③ unfold the 2 connected plates

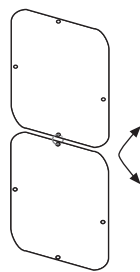

④ initially, produce only the vertical rows as described in 1 - 3

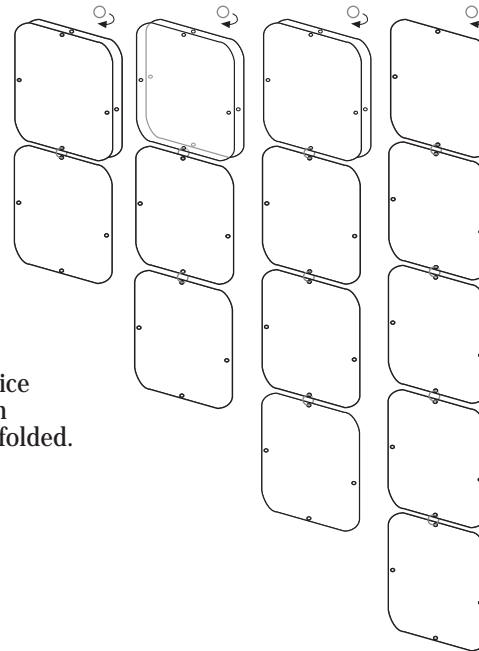

⑤ attach one connecting ring + swirl at the upper end of each row

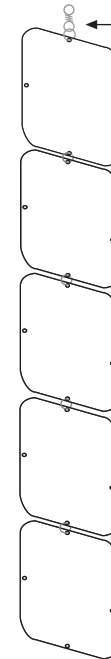

⑥ hang vertical lines on the selected device* and in succession connect them with the rings. make sure that the frosted surfaces are again on one another and the protective foil faces outwards to avoid that the rings produce scratches.

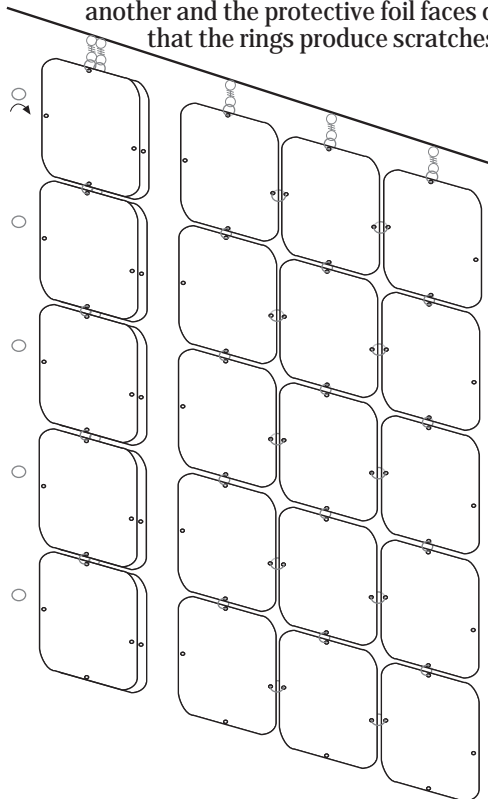

⑦ The spacing of the suspension device to the wall should be at least 10 cm be to ensure that *nolastar* can be folded.

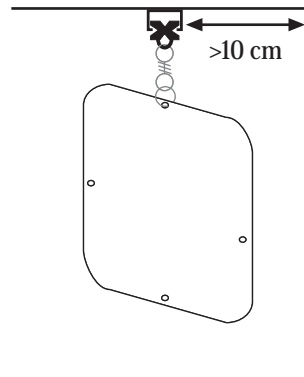

⑧ Pull off the light blue protective film only after the complete installation of *nolastar*. Any "plastic" smell disappears as soon as the protective film is removed.

Using 2 curtain rails passing each other *nolastar* can even be used after the principle of sliding doors.

For care and cleaning we recommend an anti-static cleaner.

e.g.:

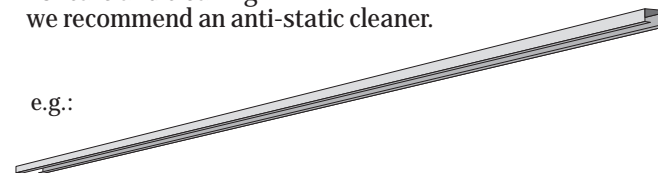

* We recommend an aluminum curtain rail with simple U-shaped profile.